



OMAN
FASTENERS

*Quality Engineered
Steel Nails*

PRODUCT BROCHURE

2	Table of Contents
3	Oman Fasteners Quality & Service
4	Manufacturing Competency
5	Collated Nails
6	Plastic Strip Nails
7	Wire Collated Nails
8	Paper Tape Nails
9	Joist Hanger / Hardware Nails
10	Plastic Sheet Siding Nails
11	Bulk Nails

Oman Fasteners

Manufacturer of Quality Engineered Steel Nails

Quality and Service

Choosing the right supply partner is essential to promoting the integrity of your business. Oman Fasteners differentiates itself with an absolute commitment to Quality and Service. Our nails are engineered to exacting specifications and we've earned industry wide confidence by placing the highest value on quality and service. We guarantee our products to be free from defect and we assure that your order arrives accurately, with precise timeliness. Our Atlanta, GA based office is available at any time to promptly provide information and address your needs.

Our product range includes every collation type and is complemented by complete array of finish types including Bright, Electro-galvanized, Hot Dip Galvanized, Vinyl Coated, and Stainless Steel.

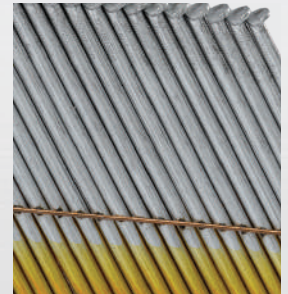
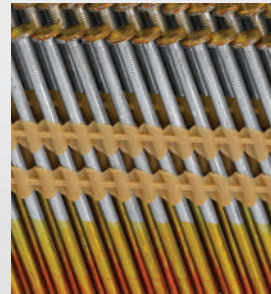
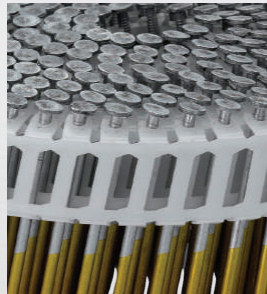
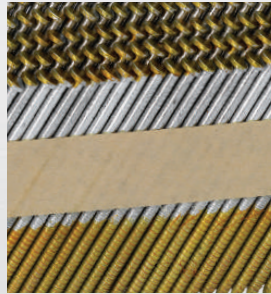
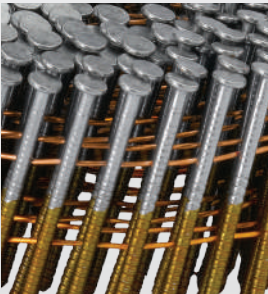



COMPETENT



Oman Fasteners utilizes state of the art equipment and technology through every step of the manufacturing process

OMAN FASTENERS utilizes state of the art equipment and technology through every step of the manufacturing process. Quality is constantly monitored and strict production records are kept in accordance with ISO and ICC ES standards. Our production facilities and processes are regularly audited for compliance by our internal Quality Assurance Team.

We keep capacity ahead of demand in order to maintain standard setting lead-times as our business continues to grow.

We continually invest in the latest technology to improve production efficiency allowing us to produce at the highest levels of quality and the lowest possible cost.

OMAN FASTENERS maintains its own ICC ES evaluation report - ESR 3434

NAIL HEAD TYPES



FULL ROUND HEAD



CLIPPED HEAD



FULL ROUND HEAD OFFSET

NAIL SHANK TYPES

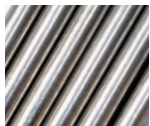

SMOOTH Most common, enough holding power for most uses



RING For superior holding power over smooth shank

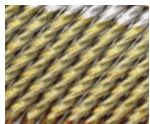

SCREW Nail turns like a screw as it is driven to prevent splitting

NAIL POINT TYPES

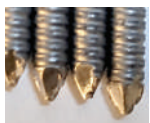

BLUNT DIAMOND Reduces splitting



DIAMOND Easy drivability, prevents splitting in soft woods

FINISH TYPES

BRIGHT	No coating. Recommended only for indoor use.
ELECTRO GALVANIZED	Steel electroplated with zinc to provide minimal corrosion resistance
HOT DIPPED GALVANIZED	Steel dipped in zinc to provide excellent corrosion resistance for exterior use
VINYL COATED	For ease of drivability and better holding power
STAINLESS STEEL	Highest corrosion resistance for use in treated lumber, cedar and coastal areas

TYPES OF COLLATION

21° Plastic Strip

- Framing
- Trusses
- Subfloor
- Roof Decking
- Wall Sheathing

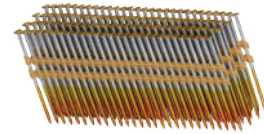

33° Paper Tape

- Framing
- Trusses
- Subfloor
- Roof Decking
- Wall Sheathing

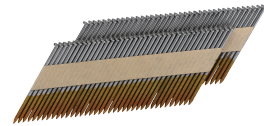

28° Wire Weld

- Framing
- Trusses
- Subfloor
- Roof Decking
- Wall Sheathing

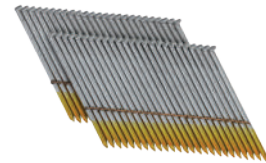

36° Paper Tape

- Joist Hangers
- Hardware



15° Wire Coil

- Framing
- Wall Sheathing
- Subfloor
- Roof Decking
- Exterior Deck

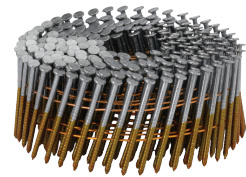

15° Wire Coil

- Roofing

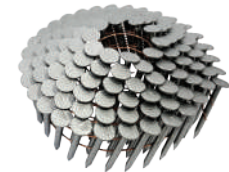

0° & 15° Plastic Sheet

- Siding
- Fencing

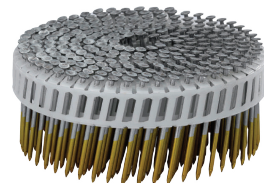

21° PLASTIC STRIP

PRIMARY APPLICATION

Framing, Sheathing, Decking, Crating

FINISH TYPES

Bright, Electro Galvanized, Hot Dipped Galvanized, Vinyl Coated, Stainless Steel

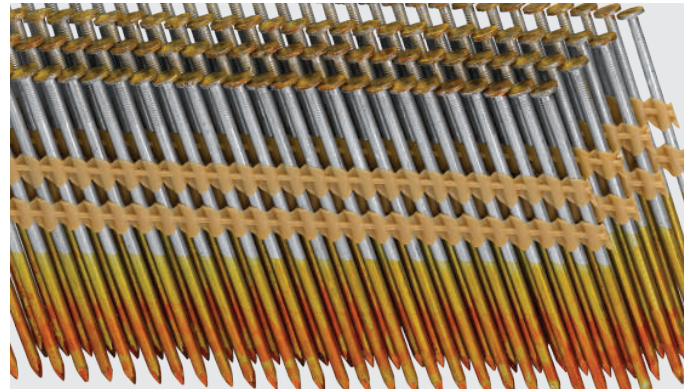

Length	Diameter	M's/Ctn	Ctns/Pkt	Approx. Ctn Wt (lbs).
1-1/2"	.148	5	48	34.90
2"	.113	6	48	34.90
2-1/8"	.135	4	48	34.86
2-1/8"	.148	4	48	42.00
2-1/4"	.148	4	48	44.31
2-3/8"	.113	5	48	34.24
2-3/8"	.135	4	48	39.00
2-3/8"	.148	4	48	46.65
2-1/2"	.113	5	48	41.95
2-1/2"	.120	4	48	36.13
2-1/2"	.131	5	48	47.93
2-1/2"	.162	4	48	58.79
2-3/4"	.120	4	48	36.13
2-3/4"	.135	4	48	44.99
3"	.120	4	48	38.67
3"	.131	4	48	45.70
3"	.148	4	48	59.19
3-1/4"	.120	4	48	42.81
3-1/4"	.131	4	48	49.54
3-1/4"	.135	4	48	53.44
3-1/4"	.148	3	48	51.68
3-1/4"	.162	3	48	59.06
3-1/2"	.131	4	48	52.80
3-1/2"	.135	4	48	54.10
3-1/2"	.162	3	48	58.53

Meets or exceeds FN1667

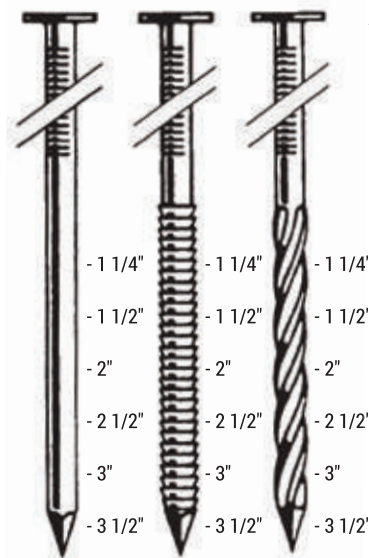

ALL SIZES AVAILABLE IN
Smooth, Ring and Screw Shanks

Smooth Ring Screw

FOR USE IN THE FOLLOWING NAILERS:

Hitachi	NR83A, NR83A2, NR83A3, NR90AC2, NR90AC3, NR90AE, NR90GR, NR90GR2	
Bostitch	N95RHN	
Craftsman	18365, 18436	
DeWalt	D51845	
DuoFast	CN350B, NSP350F, NSP350F1	
Makita	AN8300, AN922	
Max	SN890RH, SN80, SN90	
Paslode	F450SRH, 5325SRH, 5320SRH-20	
Porter Cable	FR350, FR350MAG	
Senco	SN60, SN65, SN65C, 600FRH, 602, 652, 700XLFHRM 750XLFHR	

15° WIRE COIL / 15° WIRE COIL SIDING

PRIMARY APPLICATION

Framing, Sheathing, Decking, Siding, Crating, Pallet Manufacturing

FINISH TYPES

Bright, Electro Galvanized, Hot Dipped Galvanized, Vinyl Coated, Stainless Steel, Hardened

Length	Diameter	M's/Ctn	Ctns/Plt	Approx. Ctn Wt (lbs.)
1-1/4"	.083	16	40	32.21
1-1/4"	.086	18	45	45.78
1-1/4"	.092	3.6	48	8.75
1-1/2"	.083	16	40	38.62
1-1/2"	.086	15	45	43.67
1-1/2"	.092	3.6	48	10.49
1-1/2"	.099	4.5	48	15.52
1-1/2"	.113	4.5	48	16.29
1-3/4"	.083	16	40	45.11
1-3/4"	.086	13.5	45	45.44
1-3/4"	.090	3.6	48	13.01
1-3/4"	.092	3.6	60	12.59
1-3/4"	.099	9	40	36.50
2"	.083	12	40	38.62
2"	.086	10.8	45	42.67
2"	.090	3.6	48	14.66
2"	.092	3.6	60	14.40
2"	.099	9	40	41.42
2"	.113	5	56	29.08
2-1/4"	.083	12	40	43.51
2-1/4"	.090	3.6	48	18.63
2-1/4"	.092	3.6	60	16.20
2-1/4"	.099	9	40	46.58
2-1/4"	.113	4.5	48	29.19
2-3/8"	.099	9	40	49.12
2-3/8"	.113	5	48	34.24
2-3/8"	.131	5	48	46.12
2-1/2"	.083	12	40	48.28
2-1/2"	.090	3.6	48	18.32
2-1/2"	.092	3.6	60	18.03
2-1/2"	.099	5	48	28.78
2-1/2"	.113	4.5	56	32.74
2-1/2"	.131	4.5	48	43.14
2-3/4"	.099	5	40	28.77
2-3/4"	.113	5	48	38.41
3"	.120	4	45	38.67
3"	.131	4	45	45.70
3-1/4"	.120	4	45	42.81
3-1/4"	.131	4	45	49.54

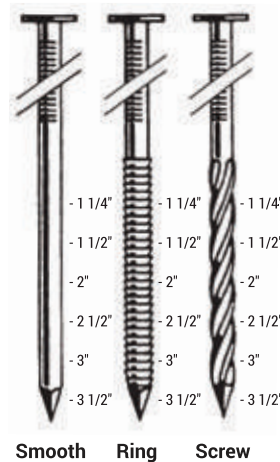
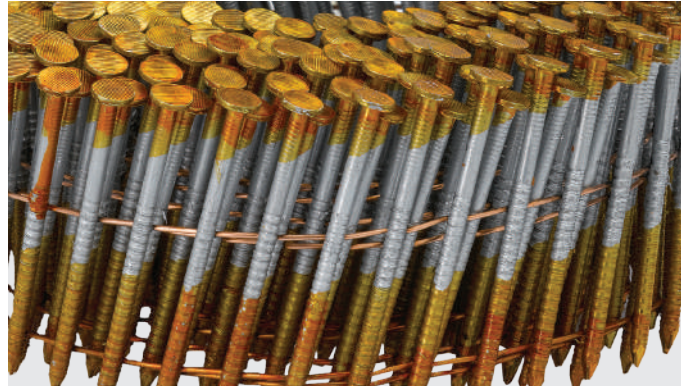

Smooth Ring Screw

ALL SIZES AVAILABLE IN
Smooth, Ring and Screw Shanks

FOR USE IN THE FOLLOWING NAILERS:

Hitachi	NV50AE, NV65AB, NV65AC, NV65AH, NV75AG, NV83A2, NV83A3, NV83A4, NV90AG	
Arto	ROLL75, ROLL85, ROLL700, RHC900, RHC1000	
Basso	NC-83H	
Bea	T0501, T-701	
Bostitch	N63CP, N55C, N100C, N80C, N70C, N86C, N80CB, N55C	
Fasco	F5C-CN15W-65CT, F5-CN-15W-75CT, F5-CN-15W-90CT	
Grex	CN70, CN90	
Grip-Rite	GRPCF325	
Makita	AN901, AN621	
Max	CN55, CN502, CN565, CN56D, CN665	
Paslode	4275CN-70, 5325CN-80, F275C, F325C	
Porter Cable	COIL 250, COIL 350	
Senco	SCN 300(75), SCN60, SCN65	
Spotnail	YCN83, MCW64	
Stantech	SDCN12B-1, SDCN12B-2	
Techikawa	TN-650, TN500	
Unicatch	UNC325	

WIRE COIL

WIRE COIL SIDING

33° PAPER TAPE (Available in Clipped & Full Round Offset Head)

PRIMARY APPLICATION

Floor & Wall Framing, Truss Build Up, Window Build Up, Subfloor, Roof Decking, Wall Sheathing, etc.

FINISH TYPES

Bright, Electro Galvanized, Hot Dipped Galvanized, Vinyl Coated, Stainless Steel

Length	Diameter	M's/Ctn	Ctns/Plt	Approx. Ctn Wt (lbs).
2"	.113	4.8	48	31.30
2"	.120	4.8	80	30.84
2-3/8"	.113	4.8	80	32.36
2-3/8"	.120	4.8	80	36.86
2-1/2"	.131	2.5	84	23.94
2-3/4"	.120	4.8	80	41.00
3"	.120	2.5	84	23.85
3"	.131	2.5	84	28.00
3-1/4"	.120	2.5	84	26.12
3-1/4"	.131	2.5	84	31.13
3-1/2"	.131	2.5	84	37.13

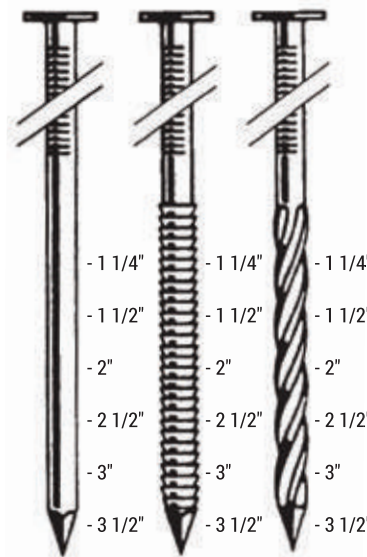
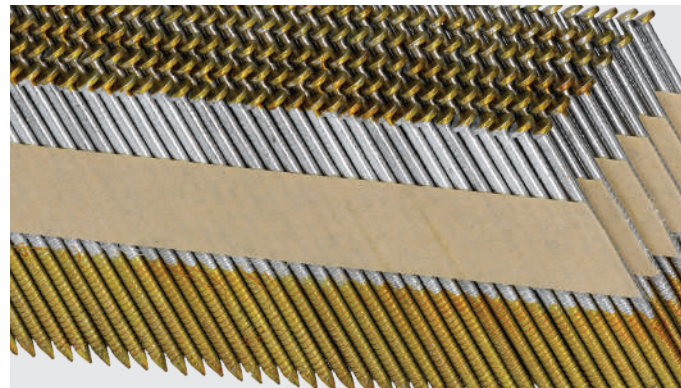

ALL SIZES AVAILABLE IN
Smooth, Ring and Screw Shanks

Smooth Ring Screw



FOR USE IN THE FOLLOWING NAILERS:

Hitachi	NR83AA, NR83AA2, NR83AA3, NR83AA4, NR90AD, NR90GC, NR90GC2	
Bostitch	N90PT	
DeWalt	D51823	
DuoFast	CN25B	
Makita	AN942	
Paslode	F350S, 5300S, F3255, S250S, SK312, IM325, IM350	
Porter Cable	FC350	
Senco	SN2, SN3, SN325, SN4, SN70, 600E, 650, 700XL, 750XL	

36° PAPER TAPE JOIST HANGER

PRIMARY APPLICATION

Framing, Wall Sheathing, Subfloor, Roof Decking and Exterior Deck

FINISH TYPES

Bright, Electro Galvanized, Hot Dipped Galvanized, Vinyl Coated, Stainless Steel

Length	Diameter	M's/Ctn	Ctns/Plt	Approx. Ctn Wt (lbs).
1-1/2"	.131	4	96	26.01
1-1/2"	.148	3	96	22.20
2-1/2"	.131	2.5	96	24.16
2-1/2"	.148	2.5	96	29.01
2-1/2"	.162	2	96	25.20

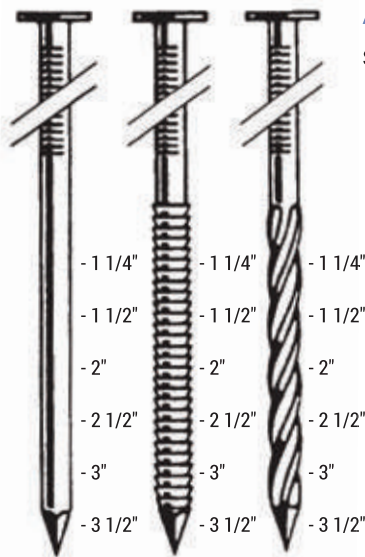

ALL SIZES AVAILABLE IN
Smooth, Ring and Screw Shanks

Smooth Ring Screw

FOR USE IN THE FOLLOWING NAILERS:

- Hitachi NR65AK, NR65AKS
- Paslode 5250/65SPP



0° & 15° PLASTIC SHEET COIL

PRIMARY APPLICATION

Siding

FINISH TYPES

Bright, Electro Galvanized, Hot Dipped Galvanized, Vinyl Coated, Stainless Steel

Length	Diameter	M's/Ctn	Ctns/Plt	Approx. Ctn Wt (lbs).
1-3/4"	.086	6	30	21.67
1-7/8"	.099	6	30	29.00
2"	.092	6	30	28.17
2-1/4"	.092	4.8	30	25.17
2-1/2"	.092	4.8	30	27.16

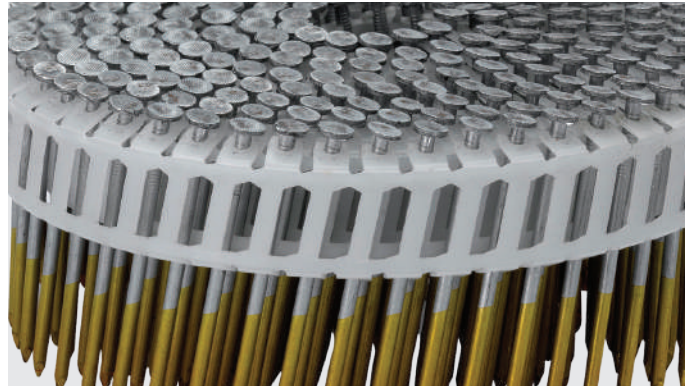

ALL SIZES AVAILABLE IN
Smooth, Ring and Screw Shanks

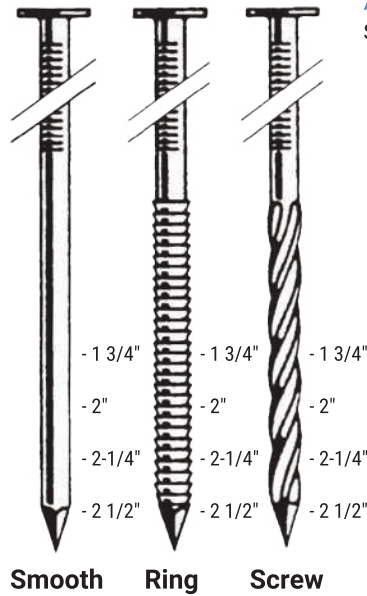

FOR USE IN THE FOLLOWING NAILERS:

- | | |
|--------------|-------------------------|
| Hitachi | NV65AH, NV65AHS, NV75AG |
| Bostitch | N66C |
| DuoFast | DF225C |
| Grip-Rite | GRTCS250 |
| Makita | AN611 |
| Max | CN565S |
| Porter Cable | COIL250 |
| Senco | SCN56 |



BULK

PRIMARY APPLICATION

Framing, Construction, Fiberglass/Shingle, Concrete, Decking, Siding

AVAILABLE SIZES

2D - 16D

AVAILABLE SHANKS

Smooth, Ring and Spiral

AVAILABLE POINTS

Based on customer requirement

AVAILABLE COATINGS

Bright, Electro Galvanized, Hot Dipped Galvanized, Stainless Steel (304 / 316)

AVAILABLE PACKAGING

50 LBS, 25 LBS, 5 LBS, 1 LB



AVAILABLE NAIL TYPES:

Common	Roofing
Box	Underlayment
Finish	Casing
Siding	Duplex
Decking	Drywall
Joist Hanger	Truss
Sinker	

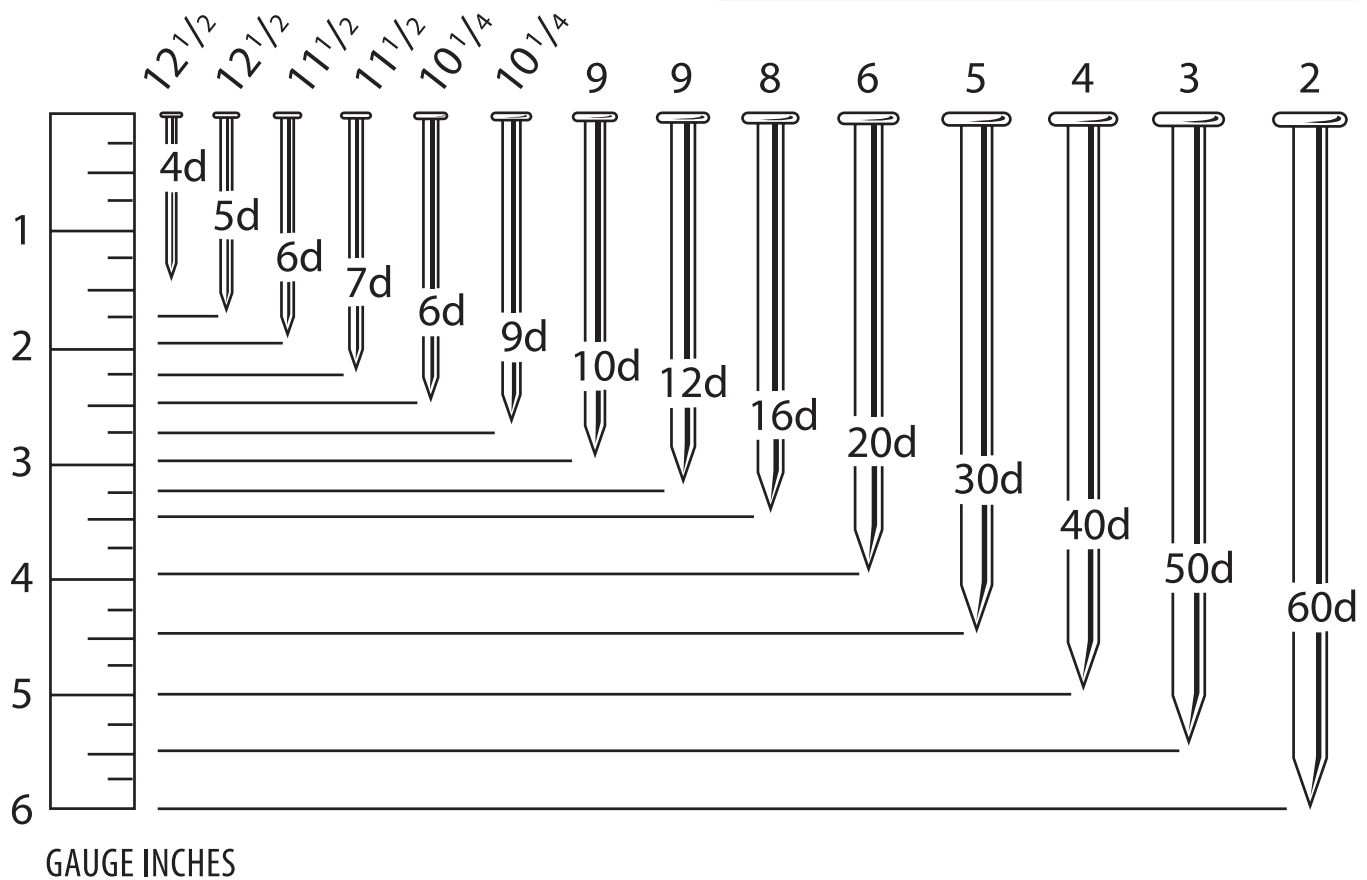

BULK NAILS

www.omanfasteners.com



Oman Fasteners Company L.L.C
Post Box: 584, Postal Code: 322,
Plot No: 5117, Sohar PEIE Industrial Area
Phase-5, Sohar, Sultanate of Oman

+968 2670 1727
+968 2670 1728
+968 2670 1726

Oman Fasteners (US OFFICE)

999 Peachtree St. NE, Suite 427
Atlanta, Georgia 30309
United States of America
+1-770- 331-1078

sales@omanfasteners.com

OMAN FASTENERS

Quality Engineered
Products

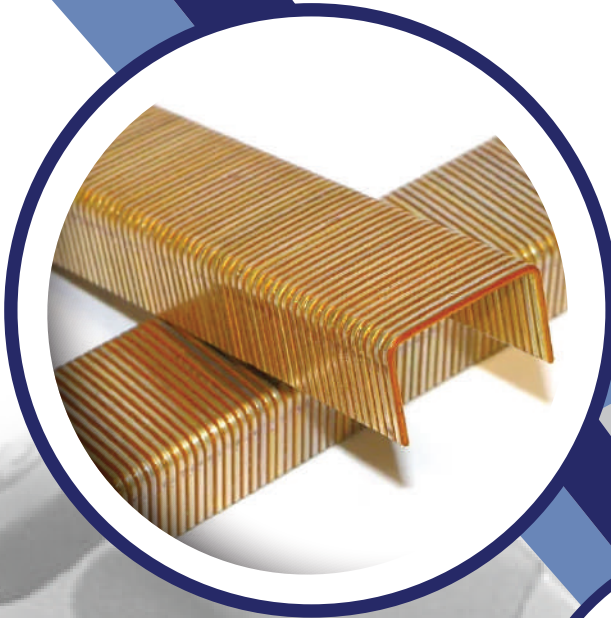

STAPLES
BRAD
MICRO PIN

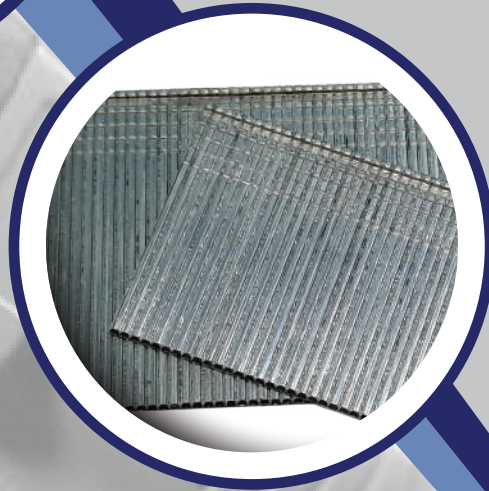

PRODUCT BROCHURE

17Ga Medium Crown

7/16" Crown, 17 Gauge (Similar to Bostitch 17S5 And Senco O series)

ITEM CODE	DESCRIPTION	POINT	QTY/CLIP	M/CTN	COAT
17S5-12G	7/16" Crown x 1/2" Leg	Chisel	70	10.0 M	EG & SS
17S5-15G	7/16" Crown x 5/8" Leg	Chisel	70	10.0 M	EG & SS
17S5-19G	7/16" Crown x 3/4" Leg	Chisel	70	10.0 M	EG & SS
17S5-22G	7/16" Crown x 7/8" Leg	Chisel	70	10.0 M	EG & SS
17S5-25G	7/16" Crown x 1" Leg	Chisel	70	10.0 M	EG & SS
17S5-28G	7/16" Crown x 1-1/8" Leg	Chisel	70	10.0 M	EG & SS
17S5-32G	7/16" Crown x 1-1/4" Leg	Chisel	70	10.0 M	EG & SS
17S5-34G	7/16" Crown x 1-3/8" Leg	Chisel	70	10.0 M	EG & SS
17S5-38G	7/16" Crown x 1-1/2" Leg	Chisel	70	10.0 M	EG & SS
17S5-41G	7/16" Crown x 1-5/8" Leg	Chisel	70	10.0 M	EG & SS
17S5-44G	7/16" Crown x 1-3/4" Leg	Chisel	70	10.0 M	EG & SS
17S5-50G	7/16" Crown x 2" Leg	Chisel	70	10.0 M	EG & SS



Suitable Tools:
 Bostitch-NS20XP
 Senco-NS20XP
 Everwin-SN41S5,SN50S5

16Ga Medium Crown

7/16" Crown, 16 Gauge (Similar to Senco N Series and ISM 100 Series)

ITEM CODE	DESCRIPTION	POINT	QTY/CLIP	M/CTN	COAT
N08	7/16" Crown x 1/2" Leg	Chisel	70	10.0 M	EG & SS
N10	7/16" Crown x 5/8" Leg	Chisel	70	10.0 M	EG & SS
N11	7/16" Crown x 3/4" Leg	Chisel	70	10.0 M	EG & SS
N12	7/16" Crown x 7/8" Leg	Chisel	70	10.0 M	EG & SS
N13	7/16" Crown x 1" Leg	Chisel	70	10.0 M	EG & SS
N14	7/16" Crown x 1-1/8" Leg	Chisel	70	10.0 M	EG & SS
N15	7/16" Crown x 1-1/4" Leg	Chisel	70	10.0 M	EG & SS
N16	7/16" Crown x 1-3/8" Leg	Chisel	70	10.0 M	EG & SS
N17	7/16" Crown x 1-1/2" Leg	Chisel	70	10.0 M	EG & SS
N18	7/16" Crown x 1-5/8" Leg	Chisel	70	10.0 M	EG & SS
N19	7/16" Crown x 1-3/4" Leg	Chisel	70	10.0 M	EG & SS
N21	7/16" Crown x 2" Leg	Chisel	70	10.0 M	EG & SS



Suitable Tools:
 Metabo-N5008AC2
 Senco-NS20XP
 Everwin-SN41S5,SN50S5

7/16" Crown, 16 Gauge (Similar to Duo-Fast 7600 or 76 Series)

ITEM CODE	DESCRIPTION	POINT	QTY/CLIP	M/CTN	COAT
7632	7/16" Crown x 1" Leg	Chisel	70	10.0 M	EG & SS
7640	7/16" Crown x 1-1/4" Leg	Chisel	70	10.0 M	EG & SS
7648	7/16" Crown x 1-1/2" Leg	Chisel	70	10.0 M	EG & SS
7656	7/16" Crown x 1-3/4" Leg	Chisel	70	10.0 M	EG & SS
7664	7/16" Crown x 2" Leg	Chisel	70	10.0 M	EG & SS



Suitable Tools:
 Max-TA551B/16-11

1/2" Crown, 16 Gauge, Galvanized (Similar to Bostitch 16S4 BCS Series)

ITEM CODE	DESCRIPTION	POINT	QTY/CLIP	M/CTN	COAT
BCS1105	1/2" Crown x 1" Leg	Chisel	70	10.0 M	EG & SS
BCS1107	1/2" Crown x 1-1/4" Leg	Chisel	70	10.0 M	EG & SS
BCS1109	1/2" Crown x 1-1/2" Leg	Chisel	70	10.0 M	EG & SS
BCS1111	1/2" Crown x 1-3/4" Leg	Chisel	70	10.0 M	EG & SS
BCS1112	1/2" Crown x 2" Leg	Chisel	70	10.0 M	EG & SS



Suitable Tools:
Bostitch-650S4-1, 438S4(538S4)

1/2" Crown, 16 Gauge, (Similar to Paslode GS Series)

ITEM CODE	DESCRIPTION	POINT	QTY/CLIP	M/CTN	COAT
GS16-1	1/2" Crown x 1" Leg	Chisel	70	10.0 M	EG & SS
GS16-114	1/2" Crown x 1-1/4" Leg	Chisel	70	10.0 M	EG & SS
GS16-112	1/2" Crown x 1-1/2" Leg	Chisel	70	10.0 M	EG & SS
GS16-134	1/2" Crown x 1-3/4" Leg	Chisel	70	10.0 M	EG & SS
GS16-2	1/2" Crown x 2" Leg	Chisel	70	10.0 M	EG & SS



Suitable Tools:
Metabo-N5010A
Paslode-SCS200

15Ga Medium Crown

7/16" Crown, 15 Gauge, Galvanized (unless specified otherwise) (Similar to Senco Q Series)

ITEM CODE	DESCRIPTION	POINT	QTY/CLIP	M/CTN	COAT
Q15	7/16" Crown x 1-1/4" Leg	Chisel	57, 55, 50	5M or ANY	EG & SS
Q17	7/16" Crown x 1-1/2" Leg	Chisel	57, 55, 50	5M or ANY	EG & SS
Q19	7/16" Crown x 1-3/4" Leg	Chisel	57, 55, 50	5M or ANY	EG & SS
Q21	7/16" Crown x 2" Leg	Chisel	57, 55, 50	5M or ANY	EG & SS
Q23	7/16" Crown x 2-1/4" Leg	Chisel	57, 55, 50	5M or ANY	EG & SS
Q25	7/16" Crown x 2-1/2" Leg	Chisel	57, 55, 50	5M or ANY	EG & SS



Suitable Tools:
Senco-SQS55XP
Jitool-JQS65

1/2" Crown, 15-1/2" Gauge, Galvanized (unless specified otherwise) (Similar to BCS 15S4 Series)

ITEM CODE	DESCRIPTION	POINT	QTY/CLIP	M/CTN	COAT
15S4-32	1/2" Crown x 1-1/4" Leg	Chisel	63, 57, 55, 50	5M or ANY	EG & SS
15S4-38	1/2" Crown x 1-1/2" Leg	Chisel	63, 57, 55, 50	5M or ANY	EG & SS
15S4-44	1/2" Crown x 1-3/4" Leg	Chisel	63, 57, 55, 50	5M or ANY	EG & SS
15S4-50	1/2" Crown x 2" Leg	Chisel	63, 57, 55, 50	5M or ANY	EG & SS
15S4-57	1/2" Crown x 2-1/4" Leg	Chisel	63, 57, 55, 50	5M or ANY	EG & SS
15S4-63	1/2" Crown x 2-1/2" Leg	Chisel	63, 57, 55, 50	5M or ANY	EG & SS

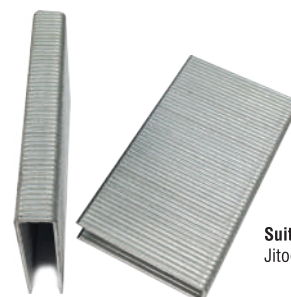

Suitable Tools:
Jitool-JQS65B

16Ga Wide Crown

15/16" Crown, 16 Gauge, Galvanized (Similar to Paslode GSW Series)

ITEM CODE	DESCRIPTION	POINT	QTY/CLIP	M/CTN	COAT
GSW16-58	15/16" Crown x 5/8" Leg	Chisel	70	10.0 M	EG & SS
GSW16-34	15/16" Crown x 3/4" Leg	Chisel	70	10.0 M	EG & SS
GSW16-78	15/16" Crown x 7/8" Leg	Chisel	70	10.0 M	EG & SS
GSW16-1	15/16" Crown x 1" Leg	Chisel	70	10.0 M	EG & SS
GSW16-114	15/16" Crown x 1-1/4" Leg	Chisel	70	10.0 M	EG & SS
GSW16-112	15/16" Crown x 1-1/2" Leg	Chisel	70	10.0 M	EG & SS
GSW16-134	15/16" Crown x 1-3/4" Leg	Chisel	70	5M or 10M	EG & SS
GSW16-2	15/16" Crown x 2" Leg	Chisel	70	5M or 10M	EG & SS



Suitable Tools:
Metabo-N5021A
Spotnails-X182640
Paslode-WCS200

1" Crown, 16 Gauge, (Similar to Bostitch 16S2 BCS Series)

ITEM CODE	DESCRIPTION	POINT	QTY/CLIP	M/CTN	COAT
BCS1096	1" Crown x 5/8" Leg	Chisel	70	10.0 M	EG & SS
BCS1097	1" Crown x 3/4" Leg	Chisel	70	10.0 M	EG & SS
BCS1098	1" Crown x 7/8" Leg	Chisel	70	10.0 M	EG & SS
BCS1099	1" Crown x 1" Leg	Chisel	70	10.0 M	EG & SS
BCS1101	1" Crown x 1-1/4" Leg	Chisel	70	10.0 M	EG & SS
BCS1102	1" Crown x 1-1/2" Leg	Chisel	70	10.0 M	EG & SS
BCS1116	1" Crown x 1-3/4" Leg	Chisel	70	5.0 M	EG & SS
BCS1117	1" Crown x 2" Leg	Chisel	70	5.0 M	EG & SS



Suitable Tools:
Bostitch-438S2-1, 450S2

1" Crown, 16 Gauge (Similar to Senco P Series and Duo-Fast 1700 Series)

ITEM CODE	DESCRIPTION	POINT	QTY/CLIP	M/CTN	COAT
P06	1" Crown x 3/8" Leg	Chisel	70	10.0 M	EG & SS
P08	1" Crown x 1/2" Leg	Chisel	70	10.0 M	EG & SS
P10	1" Crown x 5/8" Leg	Chisel	70	10.0 M	EG & SS
P11	1" Crown x 3/4" Leg	Chisel	70	10.0 M	EG & SS
P12	1" Crown x 7/8" Leg	Chisel	70	10.0 M	EG & SS
P13	1" Crown x 1" Leg	Chisel	70	10.0 M	EG & SS
P15	1" Crown x 1-1/4" Leg	Chisel	70	10.0 M	EG & SS
P17	1" Crown x 1-1/2" Leg	Chisel	70	10.0 M	EG & SS
P19	1" Crown x 1-3/4" Leg	Chisel	70	5.0 M	EG & SS
P21	1" Crown x 2" Leg	Chisel	70	5.0 M	EG & SS



Suitable Tools:
Metabo-N5024A2
Spotnails-X1S3650
Senco-PS15XP

14Ga Wide Crown

15/16" Crown, 14 Gauge, Galvanized (Similar to Paslode GSW14 Series)

ITEM CODE	DESCRIPTION	POINT	QTY/CLIP	M/CTN
GSW14-78	15/16" Crown x 7/8" Leg, High Carbon	Chisel	50 , 58	5.0 or 10M
GSW14-114	15/16" Crown x 1-1/4" Leg, High Carbon	Chisel	50 , 58	5.0 or 10M



Suitable Tools:
Spotnails-M1S2440

18Ga Narrow Crown

1/4" Crown, 18 Gauge (Similar to SENCO L Series)

ITEM CODE	DESCRIPTION	POINT	QTY/CLIP	M/CTN	COAT
L08	1/4" Crown x 1/2" Leg , EG , SS	Chisel	78 , 100	5.0 M	EG & SS
L10	1/4" Crown x 5/8" Leg , EG , SS	Chisel	78 , 100	5.0 M	EG & SS
L11	1/4" Crown x 3/4" Leg , EG , SS	Chisel	78 , 100	5.0 M	EG & SS
L12	1/4" Crown x 7/8" Leg , EG , SS	Chisel	78 , 100	5.0 M	EG & SS
L13	1/4" Crown x 1" Leg , EG , SS	Chisel	78 , 100	5.0 M	EG & SS
L14	1/4" Crown x 1-1/8" Leg , EG , SS	Chisel	78 , 100	5.0 M	EG & SS
L15	1/4" Crown x 1-1/4" Leg , EG , SS	Chisel	78 , 100	5.0 M	EG & SS
L17	1/4" Crown x 1-1/2" Leg , EG , SS	Chisel	78 , 100	5.0 M	EG & SS



Suitable Tools:
Metabo-N3804AB3
Senco-SLS150MG
Dewalt-DWFP1838
Griprite-GRTSN150

3/16" Crown, 18 Gauge (Similar to Paslode GSN Series)

ITEM CODE	DESCRIPTION	POINT	QTY/CLIP	M/CTN	COAT
GSN08	3/16" Crown x 1/2" Leg , EG , SS	Chisel	78 , 100	5.0 M	EG & SS
GSN10	3/16" Crown x 5/8" Leg , EG , SS	Chisel	78 , 100	5.0 M	EG & SS
GSN11	3/16" Crown x 3/4" Leg , EG , SS	Chisel	78 , 100	5.0 M	EG & SS
GSN12	3/16" Crown x 7/8" Leg , EG , SS	Chisel	78 , 100	5.0 M	EG & SS
GSN13	3/16" Crown x 1" Leg , EG , SS	Chisel	78 , 100	5.0 M	EG & SS
GSN14	3/16" Crown x 1-1/8" Leg , EG , SS	Chisel	78 , 100	5.0 M	EG & SS
GSN15	3/16" Crown x 1-1/4" Leg , EG , SS	Chisel	78 , 100	5.0 M	EG & SS
GSN17	3/16" Crown x 1-1/2" Leg , EG , SS	Chisel	78 , 100	5.0 M	EG & SS



Suitable Tools:
Fasco-F1B 54 DF-19
Duo-Fast-ENC 5418B

7/32" Crown, 18 Gauge (Similar to Bostitch SX5039 Series)

ITEM CODE	DESCRIPTION	POINT	QTY/CLIP	M/CTN	COAT
SX12G	7/32" Crown x 1/2" Leg , EG , SS	Chisel	78 , 100	5.0 M	EG & SS
SX58G	7/32" Crown x 5/8" Leg , EG , SS	Chisel	78 , 100	5.0 M	EG & SS
SX34G	7/32" Crown x 3/4" Leg , EG , SS	Chisel	78 , 100	5.0 M	EG & SS
SX78G	7/32" Crown x 7/8" Leg , EG , SS	Chisel	78 , 100	5.0 M	EG & SS
SX1G	7/32" Crown x 1" Leg , EG , SS	Chisel	78 , 100	5.0 M	EG & SS
SX118G	7/32" Crown x 1-1/8" Leg , EG , SS	Chisel	78 , 100	5.0 M	EG & SS
SX114G	7/32" Crown x 1-1/4" Leg , EG , SS	Chisel	78 , 100	5.0 M	EG & SS
SX112G	7/32" Crown x 1-1/2" Leg , EG , SS	Chisel	78 , 100	5.0 M	EG & SS

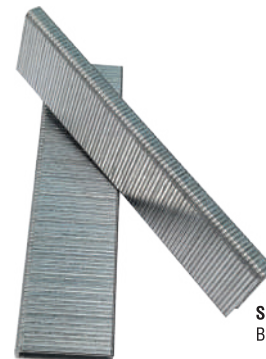

Suitable Tools:
Bostitch-SX1838K

18Ga Medium Crown

3/8" Crown, 18 Gauge (Similar to Senco M Series)

ITEM CODE	DESCRIPTION	POINT	QTY/CLIP	M/CTN	COAT
M06 M10	3/8" Crown x 3/8" Leg	Chisel	78,79,100	5.0 M	EG & SS
M08 M12	3/8" Crown x 1/2" Leg	Chisel	78,79,100	5.0 M	EG & SS
M09 M14	3/8" Crown x 9/16" Leg	Chisel	78,79,100	5.0 M	EG & SS
M10 M16	3/8" Crown x 5/8" Leg	Chisel	78,79,100	5.0 M	EG & SS
M11 M19	3/8" Crown x 3/4" Leg	Chisel	78,79,100	5.0 M	EG & SS
M12 M22	3/8" Crown x 7/8" Leg	Chisel	78,79,100	5.0 M	EG & SS
M13 M25	3/8" Crown x 1" Leg	Chisel	78,79,100	5.0 M	EG & SS
M30	3/8" Crown x 1-3/16" Leg	Chisel	78,79,100	5.0 M	EG & SS
M15 M32	3/8" Crown x 1-1/4" Leg	Chisel	78,79,100	5.0 M	EG & SS
M16 M35	3/8" Crown x 1-3/8" Leg	Chisel	78,79,100	5.0 M	EG & SS
M17 M38	3/8" Crown x 1-1/2" Leg	Chisel	78,79,100	5.0 M	EG & SS
M40	3/8" Crown x 1-9/16" Leg	Chisel	78,79,100	5.0 M	EG & SS
M18 M42	3/8" Crown x 1-5/8" Leg	Chisel	78,79,100	5.0 M	EG & SS



Suitable Tools:
Omer-SG44.38

19Ga Narrow Crown

1/4" Crown, 19 Gauge (Similar to K Series)

ITEM CODE	DESCRIPTION	POINT	QTY/CLIP	M/CTN	COAT
K08 K12	1/4" Crown x 1/2" Leg	Chisel	84, 100	10.0 M	EG & SS
K09 K916	1/4" Crown x 9/16" Leg	Chisel	84, 100	10.0 M	EG & SS
K10 K58	1/4" Crown x 5/8" Leg	Chisel	84, 100	10.0 M	EG & SS
K11 K34	1/4" Crown x 3/4" Leg	Chisel	84, 100	10.0 M	EG & SS
K1316	1/4" Crown x 13/16" Leg	Chisel	84, 100	10.0 M	EG & SS
K12 K78	1/4" Crown x 7/8" Leg	Chisel	84, 100	10.0 M	EG & SS
K13 K25	1/4" Crown x 1" Leg	Chisel	84, 100	10.0 M	EG & SS



Suitable Tools:
Senco-SLS20-K, JK-2019

20Ga staples

3/8" Crown, 20 Gauge (Similar to A11 Series)

ITEM CODE	DESCRIPTION	POINT	QTY/CLIP	M/CTN	COAT
A11-14	3/8" Crown x 1/4" Leg	Chisel , Divergents	84	5M or ANY	EG & SS
A11-516	3/8" Crown x 5/16" Leg	Chisel , Divergents	84	5M or ANY	EG & SS
A11-38	3/8" Crown x 3/8" Leg	Chisel , Divergents	84	5M or ANY	EG & SS
A11-12	3/8" Crown x 1/2" Leg	Chisel , Divergents	84	5M or ANY	EG & SS
A11-916	3/8" Crown x 9/16" Leg	Chisel , Divergents	84	5M or ANY	EG & SS
A11-58	3/8" Crown x 5/8" Leg	Chisel , Divergents	84	5M or ANY	EG & SS



Suitable Tools:
Senco-PC0700
Dewalt-DWHT75900
Bostitch-BTFP71875
Rapid-R11

1/2" Crown, 20 Gauge (Similar to 5000 Series)

ITEM CODE	DESCRIPTION	POINT	QTY/CLIP	M/CTN	COAT
5008C DF5006	1/2" Crown x 1/4" Leg	Chisel , Divergents	84	5M or ANY	EG & SS
5010C DF5008	1/2" Crown x 5/16" Leg	Chisel , Divergents	84	5M or ANY	EG & SS
5012C DF5010	1/2" Crown x 3/8" Leg	Chisel , Divergents	84	5M or ANY	EG & SS
5016C DF5012	1/2" Crown x 1/2" Leg	Chisel , Divergents	84	5M or ANY	EG & SS
5018C DF5014	1/2" Crown x 9/16" Leg	Chisel , Divergents	84	5M or ANY	EG & SS
DF5016	1/2" Crown x 5/8" Leg	Chisel , Divergents	84	5M or ANY	EG & SS

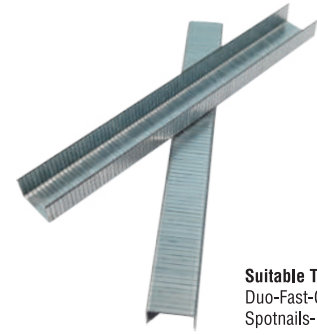

Suitable Tools:
Duo-Fast-CS-5000
Spotnails-PS5016

3/16" Crown, 20 Gauge (Similar to 5400 Series)

ITEM CODE	DESCRIPTION	POINT	QTY/CLIP	M/CTN	COAT
54-014	3/16" Crown x 1/4" Leg	Chisel , Divergents	84	5M or ANY	EG & SS
54-516	3/16" Crown x 5/16" Leg	Chisel , Divergents	84	5M or ANY	EG & SS
5412 54-038	3/16" Crown x 3/8" Leg	Chisel , Divergents	84	5M or ANY	EG & SS
5416 54-012	3/16" Crown x 1/2" Leg	Chisel , Divergents	84	5M or ANY	EG & SS
5418 54-916	3/16" Crown x 9/16" Leg	Chisel , Divergents	84	5M or ANY	EG & SS
54-058	3/16" Crown x 5/8" Leg	Chisel , Divergents	84	5M or ANY	EG & SS

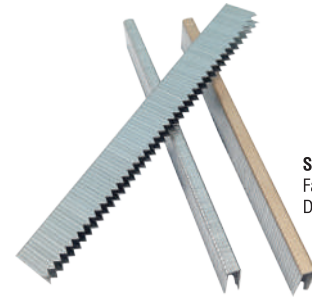

Suitable Tools:
Fasco-F1B 54 DF-19
Duo-Fast-ENC 5418B

1/2" Crown, 20 Gauge (Similar to F Series)

ITEM CODE	DESCRIPTION	POINT	QTY/CLIP	M/CTN	COAT
F04 F-014	1/2" Crown x 1/4" Leg	Chisel , Divergents	84	5M or ANY	EG & SS
F05 F-516	1/2" Crown x 5/16" Leg	Chisel , Divergents	84	5M or ANY	EG & SS
F06 F-038	1/2" Crown x 3/8" Leg	Chisel , Divergents	84	5M or ANY	EG & SS
F08 F-012	1/2" Crown x 1/2" Leg	Chisel , Divergents	84	5M or ANY	EG & SS
F09 F-916	1/2" Crown x 9/16" Leg	Chisel , Divergents	84	5M or ANY	EG & SS
F10 F-058	1/2" Crown x 5/8" Leg	Chisel , Divergents	84	5M or ANY	EG & SS

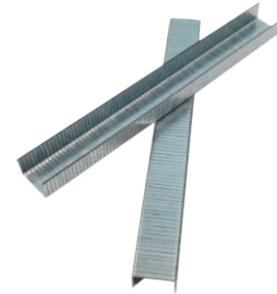

Suitable Tools:
Spotnails-PS8016

3/8" Crown, 20 Gauge (Similar to SHCR5019 Series)

ITEM CODE	DESCRIPTION	POINT	QTY/CLIP	M/CTN	COAT
SHCR501914	3/8" Crown x 1/4" Leg	Chisel , Divergents	84	5M or ANY	EG & SS
SHCR5019516	3/8" Crown x 5/16" Leg	Chisel , Divergents	84	5M or ANY	EG & SS
SHCR501938	3/8" Crown x 3/8" Leg	Chisel , Divergents	84	5M or ANY	EG & SS
SHCR501912	3/8" Crown x 1/2" Leg	Chisel , Divergents	84	5M or ANY	EG & SS
SHCR5019916	3/8" Crown x 9/16" Leg	Chisel , Divergents	84	5M or ANY	EG & SS
SHCR501958	3/8" Crown x 5/8" Leg	Chisel , Divergents	84	5M or ANY	EG & SS



Suitable Tools:
Bostitch-STCR5019
Rapid-31
Spotnails-82504

3/8" Crown, 20 Gauge (Similar to STCR5019 Series)

ITEM CODE	DESCRIPTION	POINT	QTY/CLIP	M/CTN	COAT
STCR501914	3/8" Crown x 1/4" Leg	Chisel , Divergents	84	5M or ANY	EG & SS
STCR5019516	3/8" Crown x 5/16" Leg	Chisel , Divergents	84	5M or ANY	EG & SS
STCR501938	3/8" Crown x 3/8" Leg	Chisel , Divergents	84	5M or ANY	EG & SS
STCR501912	3/8" Crown x 1/2" Leg	Chisel , Divergents	84	5M or ANY	EG & SS
STCR5019916	3/8" Crown x 9/16" Leg	Chisel , Divergents	84	5M or ANY	EG & SS
STCR501958	3/8" Crown x 5/8" Leg	Chisel , Divergents	84	5M or ANY	EG & SS



Suitable Tools:
Bostitch-H2B

22Ga Staples

3/16" Crown, 22 Gauge (Similar to A Series)

ITEM CODE	DESCRIPTION	POINT	QTY/CLIP	M/CTN	COAT
A014	3/16" Crown x 1/4" Leg	Chisel	157 OR 125	5M or ANY	EG & SS
A516	3/16" Crown x 5/16" Leg	Chisel	157 OR 125	5M or ANY	EG & SS
A038	3/16" Crown x 3/8" Leg	Chisel	157 OR 125	5M or ANY	EG & SS
A012	3/16" Crown x 1/2" Leg	Chisel	157 OR 125	5M or ANY	EG & SS
A916	3/16" Crown x 9/16" Leg	Chisel	157 OR 125	5M or ANY	EG & SS
A058	3/16" Crown x 5/8" Leg	Chisel	157 OR 125	5M or ANY	EG & SS

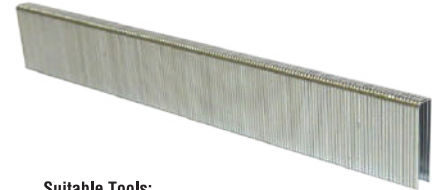

Suitable Tools:
Senco-XtremePro SFT10XP

1/2" Crown, 22 Gauge (Similar to B Series)

ITEM CODE	DESCRIPTION	POINT	QTY/CLIP	M/CTN	COAT
B04 B014	1/2" Crown x 1/4" Leg	Chisel	157 OR 125	5M or ANY	EG & SS
B05 B516	1/2" Crown x 5/16" Leg	Chisel	157 OR 125	5M or ANY	EG & SS
B06 B038	1/2" Crown x 3/8" Leg	Chisel	157 OR 125	5M or ANY	EG & SS
B08 B012	1/2" Crown x 1/2" Leg	Chisel	157 OR 125	5M or ANY	EG & SS
B09 B916	1/2" Crown x 9/16" Leg	Chisel	157 OR 125	5M or ANY	EG & SS
B10 B058	1/2" Crown x 5/8" Leg	Chisel	157 OR 125	5M or ANY	EG & SS

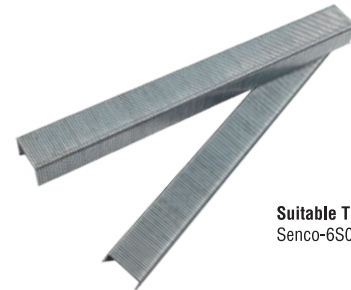

Suitable Tools:
Senco-6S0011N

3/8" Crown, 22 Gauge (Similar to C Series)

ITEM CODE	DESCRIPTION	POINT	QTY/CLIP	M/CTN	COAT
C02 71-04	3/8" Crown x 5/32" Leg	Chisel	157 OR 125	5M or ANY	EG & SS
C03 71-05	3/8" Crown x 3/16" Leg	Chisel	157 OR 125	5M or ANY	EG & SS
C04 71-06	3/8" Crown x 1/4" Leg	Chisel	157 OR 125	5M or ANY	EG & SS
C05 71-08	3/8" Crown x 5/16" Leg	Chisel	157 OR 125	5M or ANY	EG & SS
C06 71-10	3/8" Crown x 3/8" Leg	Chisel	157 OR 125	5M or ANY	EG & SS
C08 71-12	3/8" Crown x 1/2" Leg	Chisel	157 OR 125	5M or ANY	EG & SS
C09 71-14	3/8" Crown x 9/16" Leg	Chisel	157 OR 125	5M or ANY	EG & SS
C10 71-16	3/8" Crown x 5/8" Leg	Chisel	157 OR 125	5M or ANY	EG & SS



Suitable Tools:
Senco-SFW10XP-C, SFW08-C

3/8" Crown, 22 Gauge (Similar to 1400 Series)

ITEM CODE	DESCRIPTION	POINT	QTY/CLIP	M/CTN	COAT
1400-06	3/8" Crown x 1/4" Leg	Chisel	157 OR 125	5M or ANY	EG & SS
1400-08	3/8" Crown x 5/16" Leg	Chisel	157 OR 125	5M or ANY	EG & SS
1400-10	3/8" Crown x 3/8" Leg	Chisel	157 OR 125	5M or ANY	EG & SS
1400-12	3/8" Crown x 1/2" Leg	Chisel	157 OR 125	5M or ANY	EG & SS
1400-14	3/8" Crown x 9/16" Leg	Chisel	157 OR 125	5M or ANY	EG & SS
1400-16	3/8" Crown x 5/8" Leg	Chisel	157 OR 125	5M or ANY	EG & SS



Suitable Tools:
Delfast-NFS-1416HD

23Ga Staples

3/8" Crown, 23 Gauge (Similar to A19 Series)

ITEM CODE	DESCRIPTION	POINT	QTY/CLIP	M/CTN	COAT
A19-14	3/8" Crown x 1/4" Leg	Chisel	125	5M or ANY	EG & SS
A19-516	3/8" Crown x 5/16" Leg	Chisel	125	5M or ANY	EG & SS

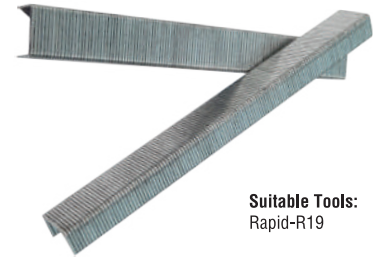

Suitable Tools:
Rapid-R19

3/8" Crown, 23 Gauge (Similar to STCR2619 Series)

ITEM CODE	DESCRIPTION	POINT	QTY/CLIP	M/CTN	COAT
STCR261914	3/8" Crown x 1/4" Leg	Chisel	125	5M or ANY	EG & SS
STCR2619516	3/8" Crown x 5/16" Leg	Chisel	125	5M or ANY	EG & SS
STCR261938	3/8" Crown x 3/8" Leg	Chisel	125	5M or ANY	EG & SS
STCR261912	3/8" Crown x 1/2" Leg	Chisel	125	5M or ANY	EG & SS
STCR2619916	3/8" Crown x 9/16" Leg	Chisel	125	5M or ANY	EG & SS
STCR261958	3/8" Crown x 5/8" Leg	Chisel	125	5M or ANY	EG & SS



Suitable Tools:
Bostitch-T6-60C2

Stick Carton Closing Staples

(Similar to A Series)

ITEM CODE	DESCRIPTION	POINT	QTY/CLIP	M/CTN	COAT
A34	1-3/8" Crown x 3/4" Leg	Chisel	50	1M,2M,5M,20M, 25M Any	EG & Copper Coat
A58	1-3/8" Crown x 5/8" Leg	Chisel	50	1M,2M,5M,20M, 25M Any	EG & Copper Coat
A78	1-3/8" Crown x 7/8" Leg	Chisel	50	1M,2M,5M,20M, 25M Any	EG & Copper Coat



(Similar to A Series)

ITEM CODE	DESCRIPTION	POINT	QTY/CLIP	M/CTN	COAT
C34	1-1/4" Crown x 3/4" Leg	Chisel	50	1M,2M,5M,20M, 25M Any	EG & Copper Coat
C58	1-1/4" Crown x 5/8" Leg	Chisel	50	1M,2M,5M,20M, 25M Any	EG & Copper Coat
C78	1-1/4" Crown x 7/8" Leg	Chisel	50	1M,2M,5M,20M, 25M Any	EG & Copper Coat



(Similar to Tripple wall Series)

ITEM CODE	DESCRIPTION	POINT	QTY/CLIP	M/CTN	COAT
TW118	1-1/4" Crown x 1-1/8" Leg	Chisel	50	1M,2M,5M,20M, 25M Any	EG & Copper Coat
TW114	1-1/4" Crown x 1-1/4" Leg	Chisel	50	1M,2M,5M,20M, 25M Any	EG & Copper Coat
TW112	1-1/4" Crown x 1-1/2" Leg	Chisel	50	1M,2M,5M,20M, 25M Any	EG & Copper Coat

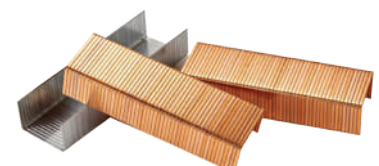

We can Do all carton closing staples Stick based On customer requirments of sizes

Coil roll Carton Closing Staples

(Similar to GR Series)

ITEM CODE	DESCRIPTION	POINT	QTY/CLIP	M/CTN	COAT
GR1 58	carton closing staples coil 5/8 legs X 1M	Chisel	1M	1M,2M,5M,20M, 25M Any	EG & Copper Coat
GR5 58	carton closing staples coil 5/8 legs X 5M	Chisel	1M	1M,2M,5M,20M, 25M Any	EG & Copper Coat
GR1 34	carton closing staples coil 3/4" legs X 1M	Chisel	1M	1M,2M,5M,20M, 25M Any	EG & Copper Coat
GR5 34	carton closing staples coil 3/4" legs X 5M	Chisel	1M	1M,2M,5M,20M, 25M Any	EG & Copper Coat



(Similar to RR Series)

ITEM CODE	DESCRIPTION	POINT	QTY/CLIP	M/CTN	COAT
RR1 58	carton closing staples coil 5/8 legs X 1M	Chisel	1M	1M,2M,5M,20M, 25M Any	EG & Copper Coat
RR5 58	carton closing staples coil 5/8 legs X 5M	Chisel	1M	1M,2M,5M,20M, 25M Any	EG & Copper Coat
RR1 34	carton closing staples coil 3/4" legs X 1M	Chisel	1M	1M,2M,5M,20M, 25M Any	EG & Copper Coat
RR5 34	carton closing staples coil 3/4" legs X 5M	Chisel	1M	1M,2M,5M,20M, 25M Any	EG & Copper Coat



(Similar to SWC7437 Series)

ITEM CODE	DESCRIPTION	POINT	QTY/CLIP	M/CTN	COAT
SWC 7437 12	carton closing staples coil 1/2" legs X 1M	Chisel	1M	1M,2M,5M,20M, 25M Any	EG & Copper Coat
SWC 7437 12 4M	carton closing staples coil 1/2" legs X 4M	Chisel	1M	1M,2M,5M,20M, 25M Any	EG & Copper Coat
SWC 7437 58	carton closing staples coil 5/8" legs X 1M	Chisel	1M	1M,2M,5M,20M, 25M Any	EG & Copper Coat
SWC 7437 58 4M	carton closing staples coil 5/8" legs X 4M	Chisel	1M	1M,2M,5M,20M, 25M Any	EG & Copper Coat
SWC 7437 34	carton closing staples coil 3/4" legs X 1M	Chisel	1M	1M,2M,5M,20M, 25M Any	EG & Copper Coat
SWC 7437 34 4M	carton closing staples coil 3/4" legs X 4M	Chisel	1M	1M,2M,5M,20M, 25M Any	EG & Copper Coat



D-Hog Ring

ITEM CODE	DESCRIPTION	POINT	QTY/CLIP	M/CTN	COAT
SR15	15Ga D-Hog Ring Staples 3/4" Crown	Chisel , Divergent	50 , Any	5M or ANY	EG



23Ga Micropin/Headless Pin

ITEM CODE	DESCRIPTION	POINT	QTY/CLIP	M/CTN	COAT
HP12	1/2" X 23Ga EG 2M X 10 Box		100	2M X 10 Box	EG
HP58	5/8" X 23Ga EG 2M X 10 Box		100	2M X 10 Box	EG
HP34	3/4" X 23Ga EG 2M X 10 Box		100	2M X 10 Box	EG
HP1	1" X 23Ga EG 2M X 10 Box		100	2M X 10 Box	EG
HP1316	1-3/16" X 23Ga EG 2M X 10 Box		100	2M X 10 Box	EG
HP138	1-3/8" X 23Ga EG 2M X 10 Box		100	2M X 10 Box	EG



Suitable Tools:
Metabo HPT-NP35A, NP50A, Senco-23LXP, Bostitch-BTFP2350K

16Ga Straight Brads

ITEM CODE	DESCRIPTION	POINT	QTY/CLIP	M/CTN	COAT
1634	16Ga Straight Brad 3/4"	Chisel	50 , 100	2.5 , 5.0M	EG & SS
1678	16Ga Straight Brad 7/8"	Chisel	50 , 100	2.5 , 5.0M	EG & SS
161	16Ga Straight Brad 1"	Chisel	50 , 100	2.5 , 5.0M	EG & SS
16118	16Ga Straight Brad 1-1/8"	Chisel	50 , 100	2.5 , 5.0M	EG & SS
16114	16Ga Straight Brad 1-1/4"	Chisel	50 , 100	2.5 , 5.0M	EG & SS
16112	16Ga Straight Brad 1-1/2"	Chisel	50 , 100	2.5 , 5.0M	EG & SS
16134	16Ga Straight Brad 1-3/4"	Chisel	50 , 100	2.5 , 5.0M	EG & SS
162	16Ga Straight Brad 2"	Chisel	50 , 100	2.5 , 5.0M	EG & SS
16214	16Ga Straight Brad 2-1/4"	Chisel	50 , 100	2.5 , 5.0M	EG & SS
16212	16Ga Straight Brad 2-1/2"	Chisel	50 , 100	2.5 , 5.0M	EG & SS

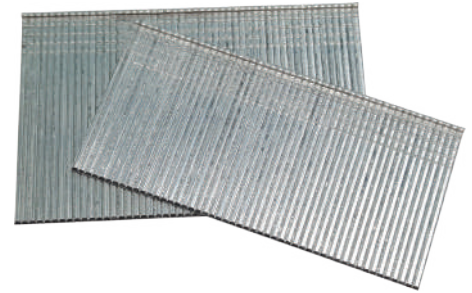

Suitable Tools:
 Metabo-NT65M2
 Max-NF565A/16
 Paslode-T250S-F16P

18Ga Straight Brads

ITEM CODE	DESCRIPTION	POINT	QTY/CLIP	M/CTN	COAT
1858	18Ga Straight Brad 5/8"	Chisel	100	5.0 M	EG & SS
1834	18Ga Straight Brad 3/4"	Chisel	100	5.0 M	EG & SS
1878	18Ga Straight Brad 7/8"	Chisel	100	5.0 M	EG & SS
181	18Ga Straight Brad 1"	Chisel	100	5.0 M	EG & SS
18118	18Ga Straight Brad 1-1/8"	Chisel	100	5.0 M	EG & SS
18114	18Ga Straight Brad 1-1/4"	Chisel	100	5.0 M	EG & SS
18112	18Ga Straight Brad 1-1/2"	Chisel	100	5.0 M	EG & SS
18134	18Ga Straight Brad 1-3/4"	Chisel	100	5.0 M	EG & SS
182	18Ga Straight Brad 2"	Chisel	100	5.0 M	EG & SS

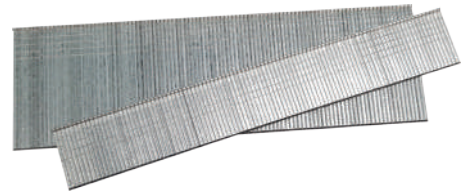

Suitable Tools:
 Metabo-NT50AE2
 Bostitch-SB-21N1

16Ga Angle Brads

ITEM CODE	DESCRIPTION	POINT	QTY/CLIP	M/CTN	COAT
16A34	16Ga Angle Brad 3/4"	Chisel	50 , 100	2.5 , 5.0M	EG
16A78	16Ga Angle Brad 7/8"	Chisel	50 , 100	2.5 , 5.0M	EG
16A1	16Ga Angle Brad 1"	Chisel	50 , 100	2.5 , 5.0M	EG
16A118	16Ga Angle Brad 1-1/8"	Chisel	50 , 100	2.5 , 5.0M	EG
16A114	16Ga Angle Brad 1-1/4"	Chisel	50 , 100	2.5 , 5.0M	EG
16A112	16Ga Angle Brad 1-1/2"	Chisel	50 , 100	2.5 , 5.0M	EG
16A134	16Ga Angle Brad 1-3/4"	Chisel	50 , 100	2.5 , 5.0M	EG
16A2	16Ga Angle Brad 2"	Chisel	50 , 100	2.5 , 5.0M	EG
16A214	16Ga Angle Brad 2-1/4"	Chisel	50 , 100	2.5 , 5.0M	EG
16A212	16Ga Angle Brad 2-1/2"	Chisel	50 , 100	2.5 , 5.0M	EG

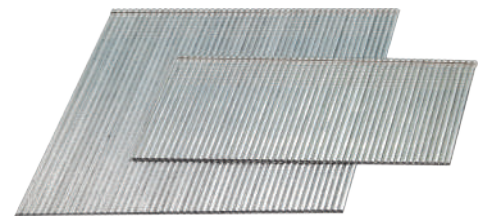



Suitable Tools:
 Dewalt-DCN660B
 Senco-GT65RHA

www.omanfasteners.com



Oman Fasteners Company L.L.C
Post Box: 584, Postal Code: 322,
Plot No: 5117, Sohar PEIE Industrial Area
Phase-5, Sohar, Sultanate of Oman

-  +968 2670 1727
-  +968 2670 1728
-  +968 2670 1726

Oman Fasteners (US OFFICE)
999 Peachtree St. NE, Suite 427
Atlanta, Georgia 30309
United States of America
 +1-770- 331-1078
 sales@omanfasteners.com